

WINE

ENOGALAX  
ONE DOOR

<b>Code</b> <b>A1GM4B1U22U</b>	<b>Description</b> <b>Refrigerated Wine Bottle Display Cabinet - ENOGALAX H2000 SINGLE SIDE</b>
-----------------------------------	--

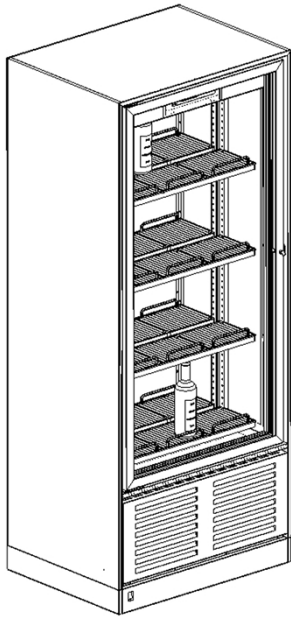

- Structure with insulated laminated panels.
- Aluminium frame and low emissivity double glazed door.
- Ventilated refrigeration digitally controlled.
- Inner layout with polycarbonate and stainless steel configurable shelves (inclination and height).
- LED lighting (3000-3500K).
- Heated drain pan for water condensation.
- Single side model with built in right handle and lock.
- Humidity control.



Non-contractual image, provided by way of example.

TECHNICAL DATA					
		Climate Class			
°F	Operating Climate Conditions		N°	Cu. ft.	Amps
+39°F +68°F	A.T. 86°F - R.H. 55%	4	192	-	3.0 / 7.0
		Energy Efficiency Class	Sound Emission Level (1)	Annual Energy Consumption (2)	
V/Ph/Hz	HFC		dB	kWh/Year	
115V/1/60 Hz	R134A				

(1) Sound pressure level measured at 3 meters in front of the product. (2) Annual Energy Consumption as Delegated Regulation 2010/1060/UE.

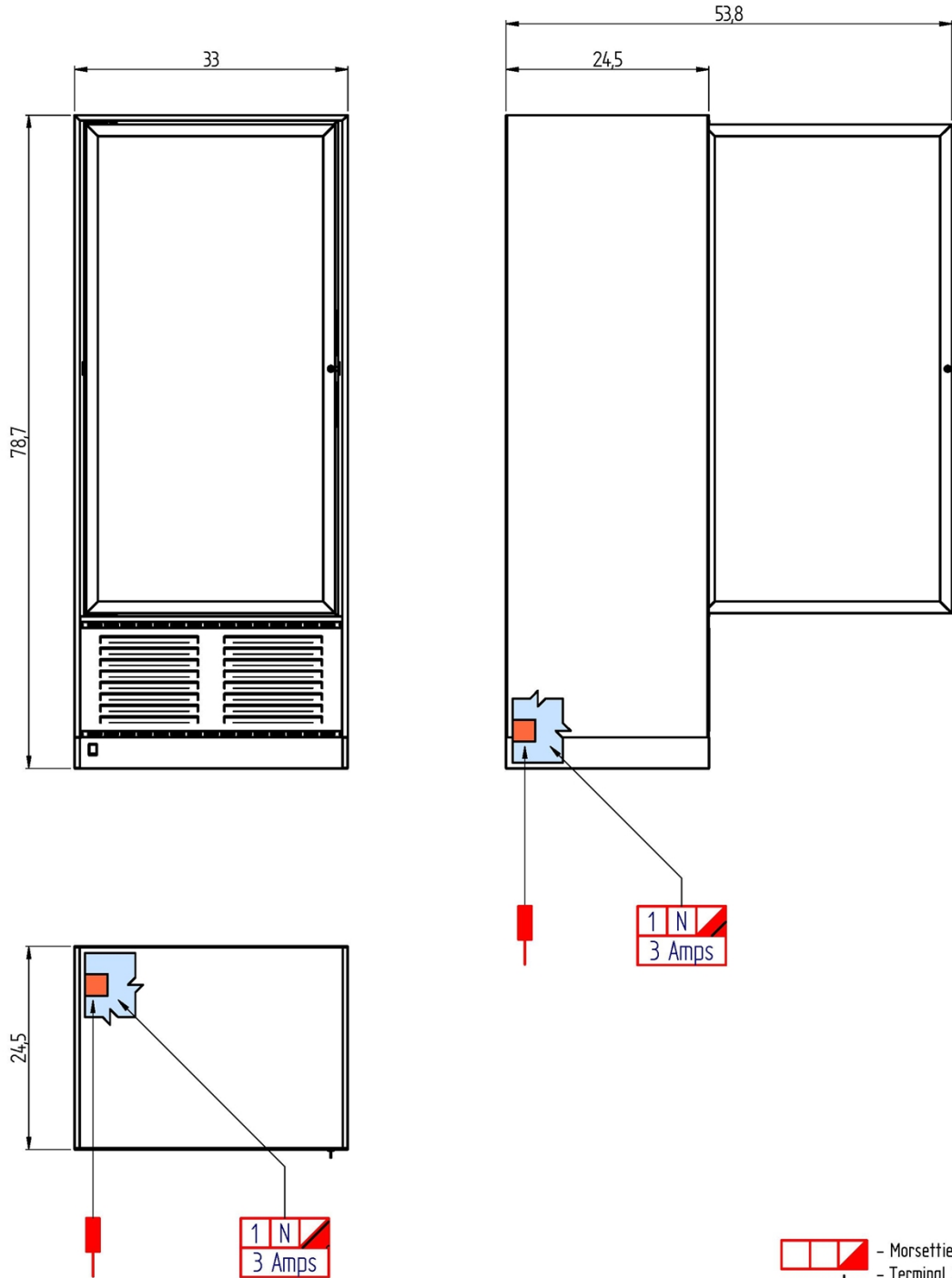
DIMENSIONS AND WEIGHTS																								
in		in		<b>1</b>	in		<b>2</b>	in		<b>3</b>	in		<b>4</b>	in		<b>5</b>	in		<b>6</b>	in		<b>6</b>		
W	D	H	W	D	H	W	D	H	W	D	H	W	D	H	W	D	H	W	D	H	W	D	H	
33 1/8	24 5/8	78 3/4	38 1/2	32	87 3/4	-	-	-	-	-	-	-	-	-	-	-	-	-	-	-	-	-	-	
			<b>1</b>				<b>2</b>				<b>3</b>				<b>4</b>				<b>5</b>				<b>6</b>	
Lbs	Lbs	Cu. ft.	Lbs	Cu. ft.	Lbs	Cu. ft.	Lbs	Cu. ft.	Lbs	Cu. ft.	Lbs	Cu. ft.	Lbs	Cu. ft.	Lbs	Cu. ft.	Lbs	Cu. ft.	Lbs	Cu. ft.	Lbs	Cu. ft.	Lbs	Cu. ft.
463	507	-	-	-	-	-	-	-	-	-	-	-	-	-	-	-	-	-	-	-	-	-	-	-
<b>Total:</b>																				Lbs	Cu. ft.			
																				507	-			



-  - Morsettiera
- Terminal board
- Tablero de terminales eléctricos
- Bornier électrique
-  115V
- Spina
- Plug
- Enchufe eléctrico
- Prise électrique

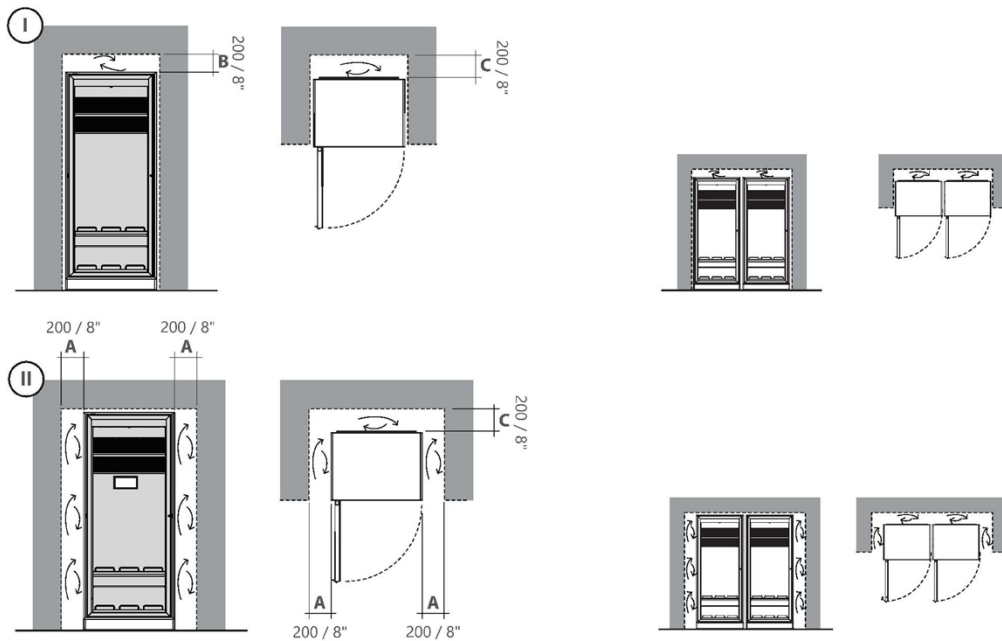
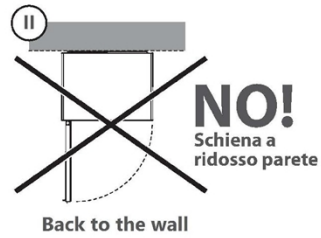
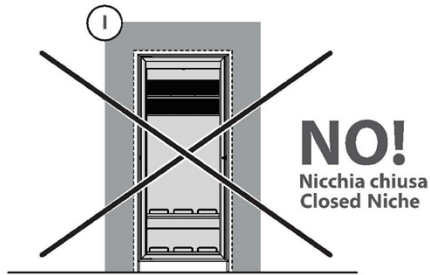

\* mm / pollici  
inches  
pulgadas  
pouces