

Model B-6

Dual Decanter Brewer



Model B-6

Digitally controlled decanter brewer, holds brew temperature to $\pm 1^\circ\text{F}$ throughout brew cycle. Brew temperature, brew volume, operator defined pre-infusion/pulse brewing, energy savings, and low temp/no brew are programmable from the front of the machine.











GRINDMASTER[™]
CORPORATION



Model B-6

Features

-  Brewer has 6 decanter warmers - 3 gallons of coffee holding capacity
-  Brew Temperature - Brewer will hold the brew temperature to +/-1°F during complete brew cycle
-  Brew Volume - Visual programming prevents multiple brew cycles to set volume
-  Pre-Infusion/Pulse Brewing - Allows brewer to extract up to 20% more coffee per batch of grounds
-  Energy Savings/Coffee Old - Warmers to be programmed to shut off and alert customer after a pre-determined hold time
-  Low Temp/No Brew - Allows the brew cycle to begin only when the water has reached optimum brewing temperature
-  Cycle Counter - stores number of brew cycles
-  Settings Lock-out - Prevents settings from being adjusted from the front of the machine

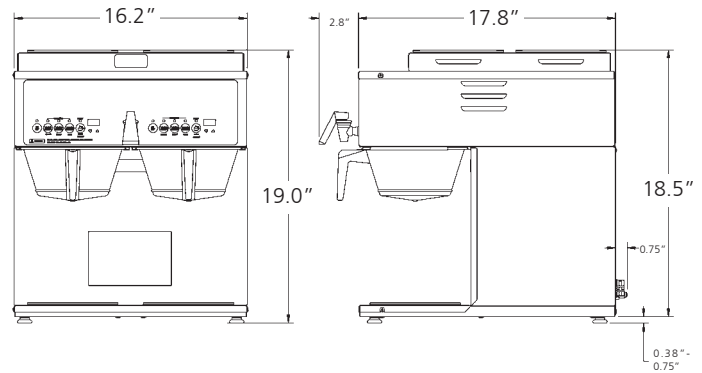

Front View

Side View

Specification	Model B-6
Electrical	120/240V, 4100W, 17.1A 120/208V, 3230W, 15.5A <i>European voltages available</i>
Brew Capacity (decanter / hour)	@ 240V: 16 @ 208V: 12
Water Line	1/4" flare
Water Line Pressure	20 to 100 psi
Tank Drain	Yes
Tank Size	4.3 Gallons
Dimensions (H x W x D)	19" H x 16.2" W x 17.8" D (48 cm x 41 cm x 45 cm)
Ship Dimensions (H x W x D)	22" H x 24" W x 21" D (56 cm x 61 cm x 53 cm)
Weight	46 lbs. (21 kg)
Ship Weight	55 lbs. (25 kg)
Listings	UL, CUL, NSF, CE

Specifications are subject to improvement or change without notice.



GRINDMASTER™
CORPORATION



Grindmaster® Coffee Grinders and Brewers • Espresso® Espresso Machines • Crathco® Hot Beverage Dispensers
Crathco® Cold and Frozen Beverage Dispensers • American Metal Ware® Coffee and Tea Systems

Tel (502) 425-4776 • Fax (502) 425-4664 • 1-800-695-4500

P.O. Box 35020 • Louisville, KY 40232 • USA

www.grindmaster.com • email: info@grindmaster.com